

Wibroizolatory gumowe typu TE

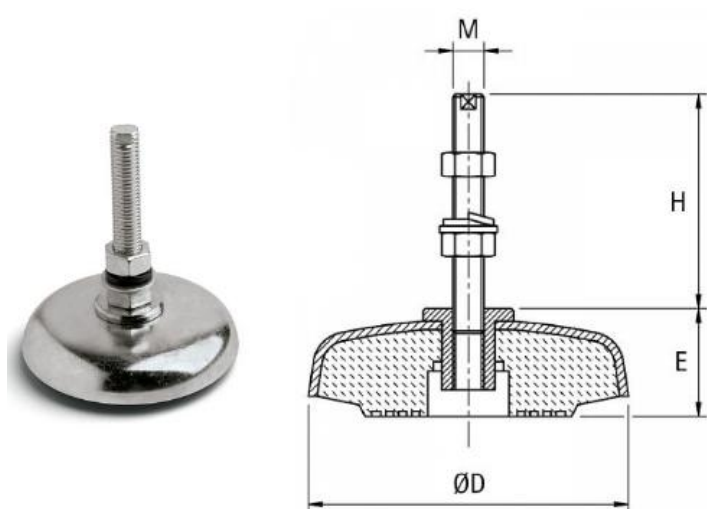

Typ Wibroizolatora	C	E	H	M	Maksymalne obciążenie statyczne [N]
TE140	140	45	110	M16	10000