

Wibroizolatory gumowe typu TE

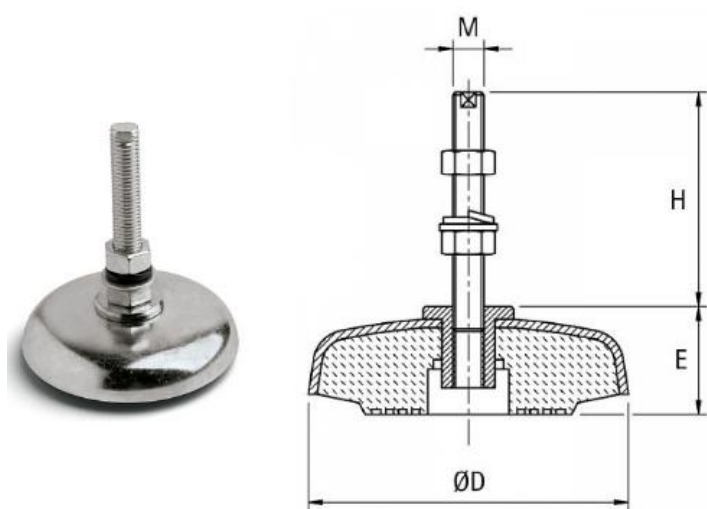

Typ Wibroizolatora	C	E	H	M	Maksymalne obciążenie statyczne [N]
TE110	110	34	110	M14	7000