

Wibroizolatory gumowy typu SCT.

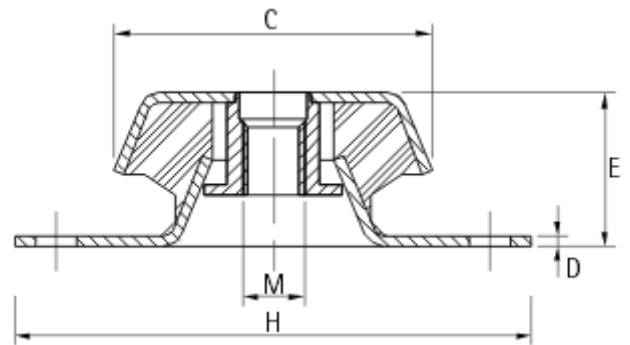

Typ Wibroizolatora	C	D	E	H	M	Maksymalne obciążenie statyczne [N]
SCT90/12	92	3	44	130	M12	3600