

Wibroizolatory gumowe typu MS

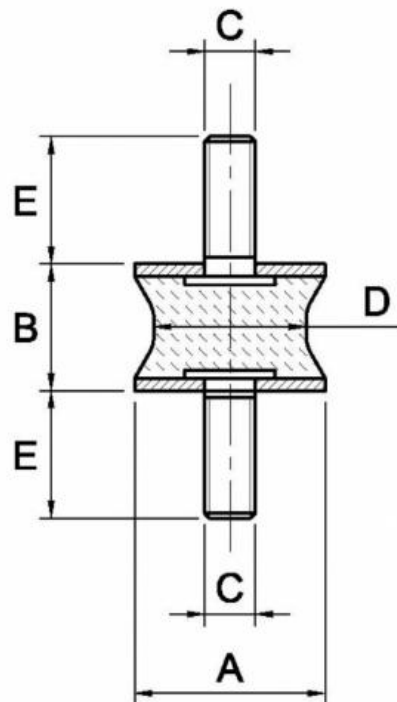

Typ Wibroizolatora	A	B	C	D	E	Maksymalne obciążenie statyczne [N]
MS40	40	30	M8	19	20	800