

Wibroizolatory gumowe typu MS

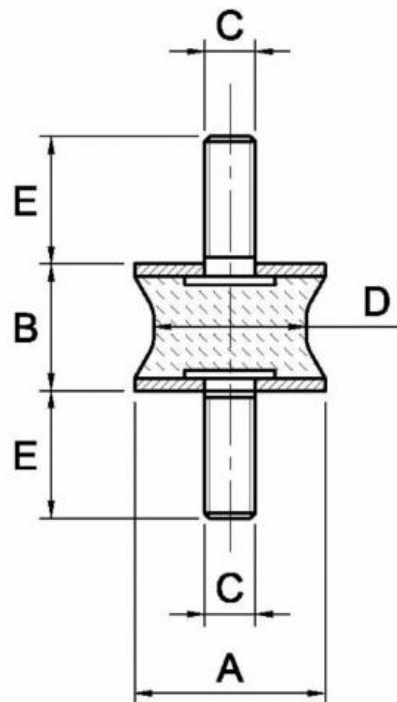

Typ Wibroizolatora	A	B	C	D	E	Maksymalne obciążenie statyczne [N]
MS12	12	15	M4	7	10	30